

Type of Modular Valve

Class	Model Numbers	Graphic Symbols	Page	Class	Model Numbers	Graphic Symbols	Page	
	Solenoid Controlled Pilot Operated Directional Valve (S-)DSHG-10-***-**-43/4390		381		Pilot Operated Check Valves (for "A-Line", Internal Pilot-) Internal Drain Type MPA-10-*-30/3090		640	
Pressure Control Valves	Reducing Valves (for "P-Line") MRP-10-*-30/3090		634		Pilot Operated Check Valves (for "A-Line", External Pilot-) External Drain Type MPA-10-*-X-30/3090		640	
	Reducing Valves (for "A-Line") MRA-10-*-30/3090		634		Pilot Operated Check Valves (for "A-Line", External Pilot-) Internal Drain Type MPA-10-*-Y-30/3090		640	
	Reducing Valves (for "B-Line") MRB-10-*-30/3090		634	Directional Control Valves	Pilot Operated Check Valves (for "B-Line", Internal Pilot-) Internal Drain Type MPB-10-*-30/3090		640	
			Pilot Operated Check Valves (for "B-Line", External Pilot-) External Drain Type MPB-10-*-X-30/3090			640		
			Pilot Operated Check Valves (for "B-Line", External Pilot-) Internal Drain Type MPB-10-*-Y-30/3090			640		
			Pilot Operated Check Valves (for "A&B-Lines", Internal Pilot-) Internal Drain Type MPW-10-*-30/3090			640		
Flow Control Valves	Throttle and Check Valves (for "A-Line", Metre-out) MSA-10-X-30/3090		637		Mounting Bolts	Bolt Kits MBK-10-*-10/1090		644
	Throttle and Check Valves (for "A-Line", Metre-in) MSA-10-Y-30/3090		637					
	Throttle and Check Valves (for "B-Line", Metre-out) MSB-10-X-30/3090		637					
	Throttle and Check Valves (for "B-Line", Metre-in) MSB-10-Y-30/3090		637					
	Throttle and Check Valves (for "A&B-Lines", Metre-out) MSW-10-X-30/3090		637					
Throttle and Check Valves (for "A&B-Lines", Metre-in) MSW-10-Y-30/3090		637						

★ Because drain ports "V" and "W" are not provided for solenoid controlled pilot operated directional valves of Pressure Centred Type (3H*) and models with Pilot Piston (P*), those valves cannot be used in combination with modular valves.

Reducing Modular Valves

Specifications

Model Numbers	Max. Operating Pressure MPa(PSI)	Max. Flow* L/min (U.S.GPM)
MR*-10-A-30/3090	25 (3630)	250 (66)
B MR*-10-C-30/3090		800 (211)
H		

★ In the pressure adjustment ranges "A" and "B", maximum flow rates are limited by the pressure setting on the secondary side.

Referring to the secondary pressure vs. maximum flow characteristics on the following page, use the valve at the maximum flow rate within a zone highlighted with .

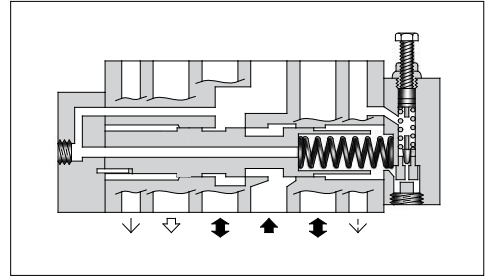

Model Number Designation

F-	MRP	-10	-B	-30	*
Special Seals	Series Number	Valve Size	Pres. Adj. Range MPa (PSI)	Design Number	Design Standard
F: Special Seals for Phosphate Ester Type Fluids (Omit if not required)	MRP: Reducing Valve for P-Line MRA: Reducing Valve for A-Line MRB: Reducing Valve for B-Line	10	A: 0.7-7 (100-1020) B: 1.5-7 (220-1020) C: 3.5-14 (510-2030) H: 7-21 (1020-3050)	30	Refer to ★

★ Design Standards: None Japanese Standard "JIS" and European Design Standard
90 N. American Design Standard

Instructions

- Connect **Drain Line (Y port)** to oil tank independently so as to obtain stable pressure setting. At the same time, the solenoid controlled pilot operated directional valve to be used in combination with this valve must be of internal drain type (with T).
- To make pressure adjustment, loosen the lock nut and turn the pressure adjustment screw clockwise or anti-clockwise. For an increase of pressure, turn the screw clockwise. Be sure to re-tighten the lock nut firmly after making adjustment to the pressure.

Graphic Symbols

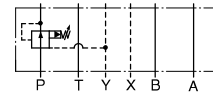

MRP-10

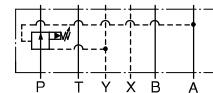

MRA-10

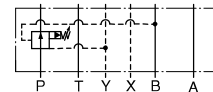

MRB-10

Typical Performance Characteristics

Hydraulic Fluid: Viscosity 35 mm²/s (164 SSU), Specific Gravity 0.850

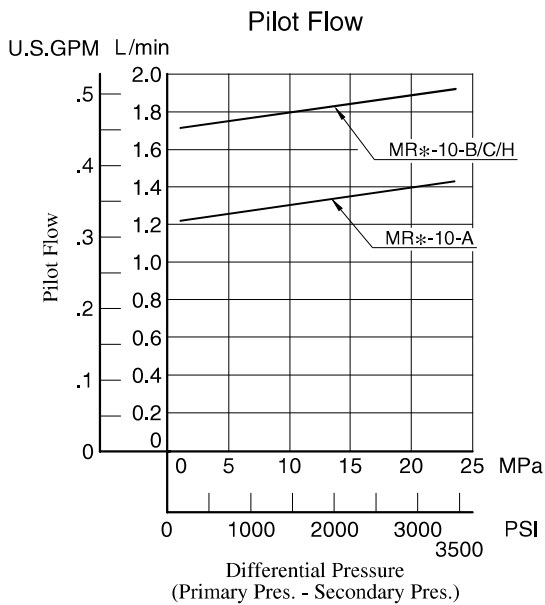
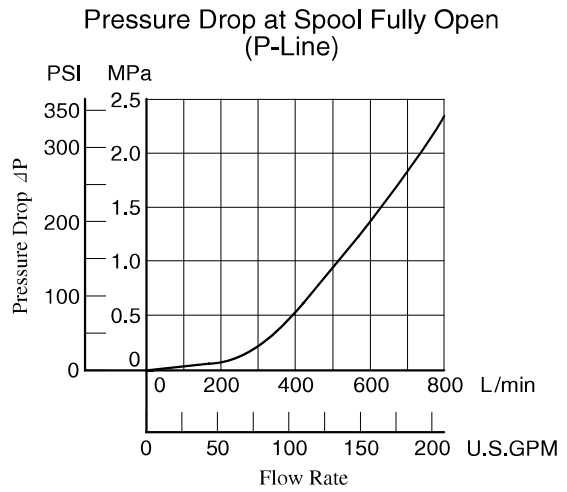
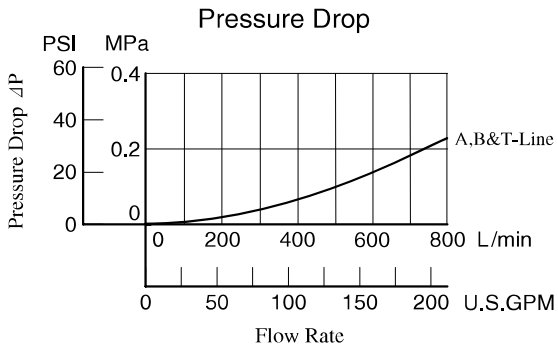

Nominal Override Characteristics

Primary Pressure 25 MPa (3630 PSI)

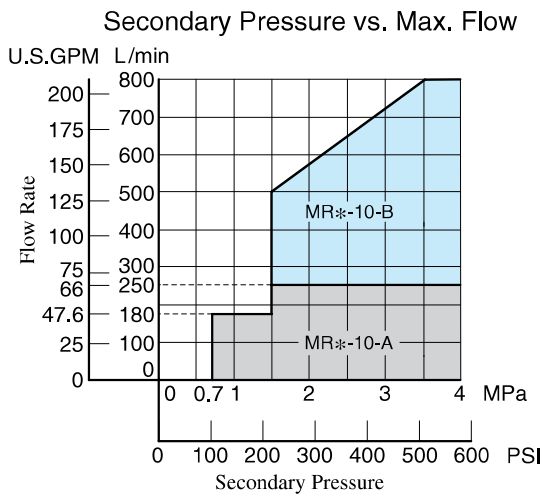
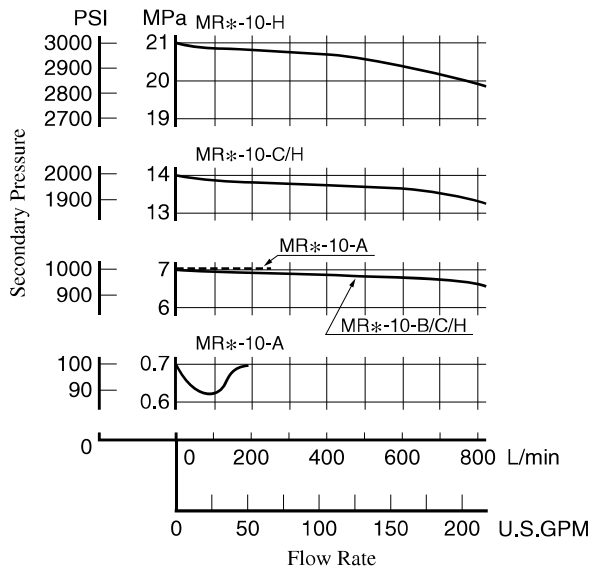

MRP-10-*-30/3090
 MRA-10-*-30/3090
 MRB-10-*-30/3090

**DIMENSIONS IN
 MILLIMETRES (INCHES)**

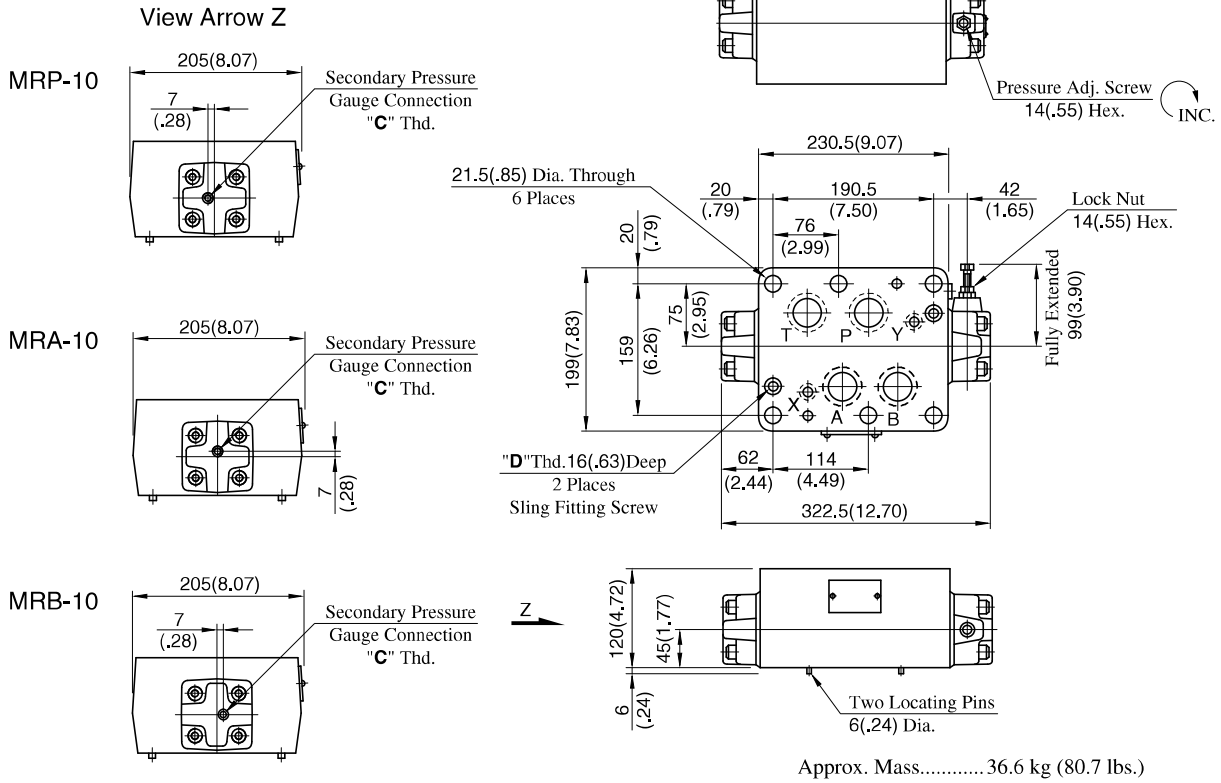

Model Numbers	Thread Size	
	"C" Thd.	"D" Thd.
MR*-10-*-30	Rc 1/4 = 1/4 BSP.Tr	M8
MR*-10-*-3090	1/4 NPT	5/16-18 UNC

■ Spare Parts List

MRP-10-*-30/3090
 MRA-10-*-30/3090
 MRB-10-*-30/3090

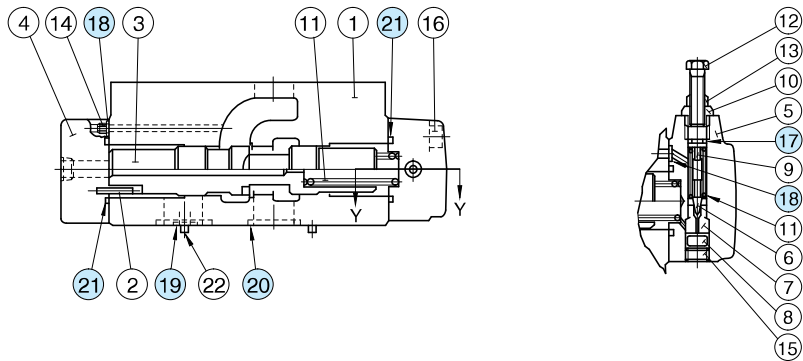

● List of Seals

Item	Name of Parts	Part Numbers	Qty.	Remarks
17	O-Ring	SO-NA-P9	1	Included in Seal Kit Kit No.: KS-MRP-10-10
18	O-Ring	SO-NB-P9	4	
19	O-Ring	SO-NB-P16	2	
20	O-Ring	SO-NB-P40	4	
21	O-Ring	SO-NB-P44	2	

Section Y-Y

Throttle and Check Modular Valves

Specifications

Model Numbers	Max. Operating Pressure MPa (PSI)	Max. Flow L/min (U.S.GPM)
MSA-10-*-30/3090 MSB-10-*-30/3090 MSW-10-*-30/3090	25 (3630)	800 (211)

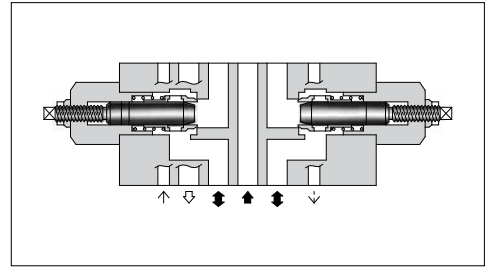

Model Number Designation

F-	MSW	-10	-X	-30	*
Special Seals	Series Number	Valve Size	Direction of Flow	Design Number	Design Standard
F: Special Seals for Phosphate Ester Type Fluids (Omit if not required)	MSA : Throttle and Check Valves for A-Line MSB : Throttle and Check Valves for B-Line MSW : Throttle and Check Valves for A&B-Lines	10	X : Metre-out Y : Metre-in	30	Refer to ★

★ Design Standards: None Japanese Standard "JIS" and European Design Standard 90 N. American Design Standard

Instructions

- To make flow rate adjustment, loosen the lock nut and turn the flow adjustment screw clockwise or anti-clockwise. To throttle the flow, turn the screw clockwise. Be sure to re-tighten the lock nut firmly after the adjustment of the flow rate is completed.

Graphic Symbols

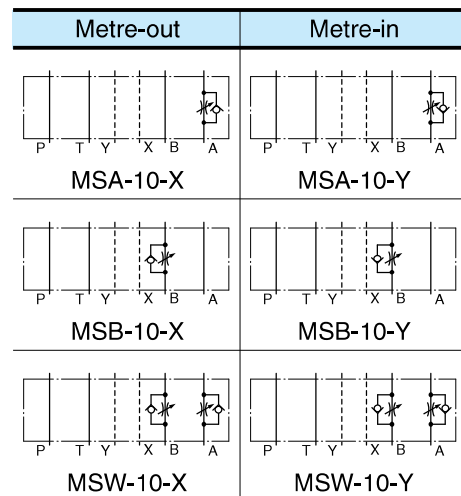

Typical Performance Characteristics

Hydraulic Fluid: Viscosity 35 mm²/s (164 SSU), Specific Gravity 0.850

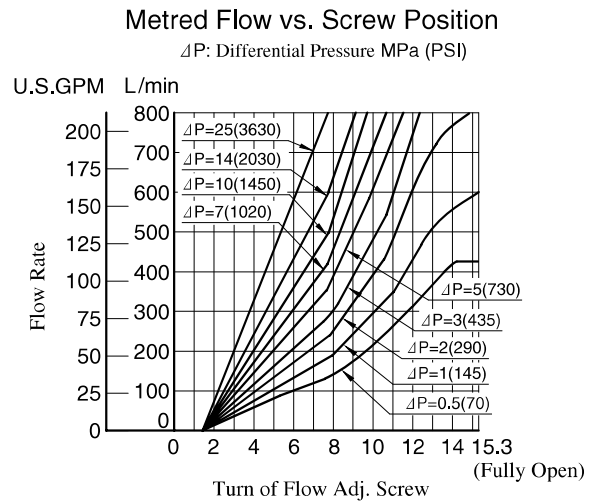
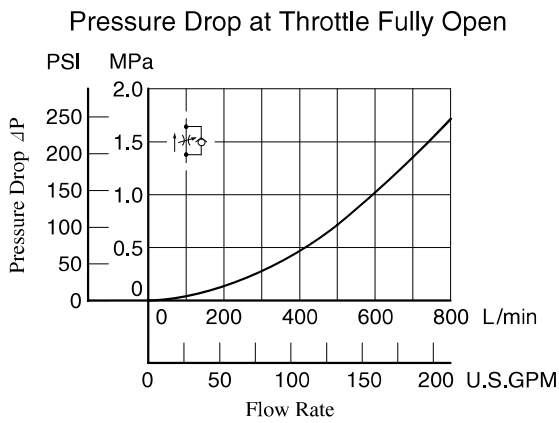
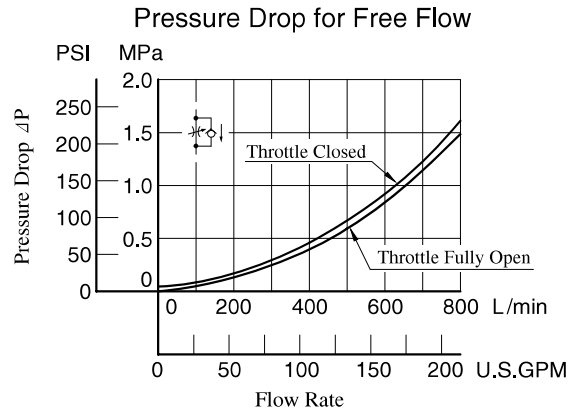
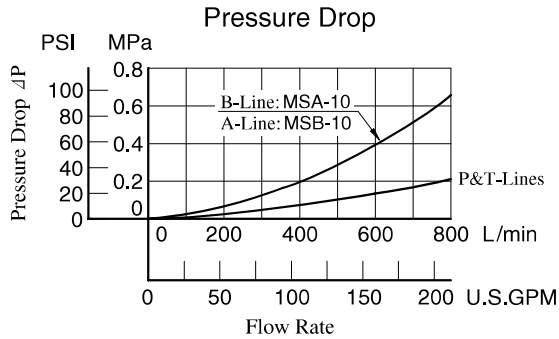

MSW-10-X-30/3090

DIMENSIONS IN MILLIMETRES (INCHES)

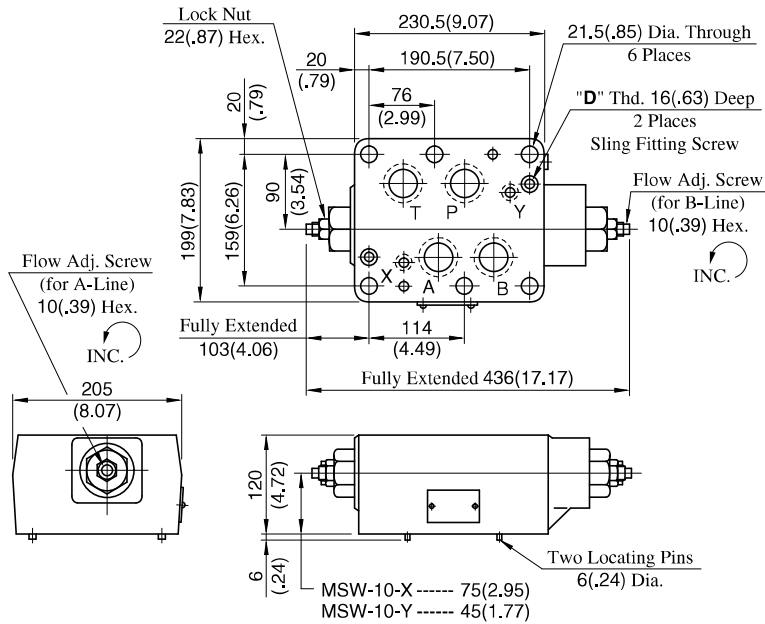

Model Numbers	"D" Thd.
MS*-10-*-30	M8
MS*-10-*-3090	5/16-18 UNC

Approx. Mass..... 35.7 kg (78.7 lbs.)

MSA-10-X-30/3090

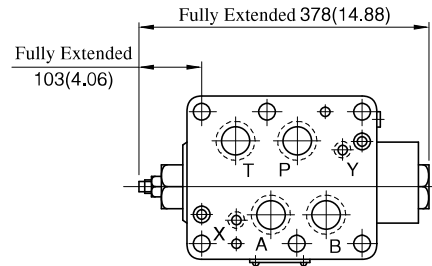

Approx. Mass..... 35 kg (77.2 lbs.)

• For other dimensions, refer to "MSW-10" drawing left.

MSB-10-X-30/3090

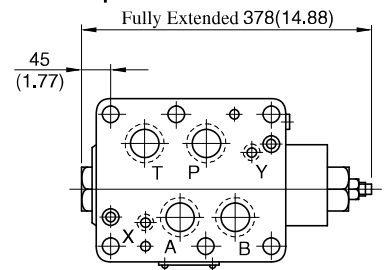

Approx. Mass..... 35 kg (77.2 lbs.)

• For other dimensions, refer to "MSW-10" drawing left.

Spare Parts List

MSA-10-*-30/3090

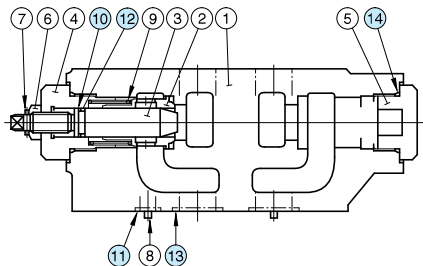

MSB-10-*-30/3090

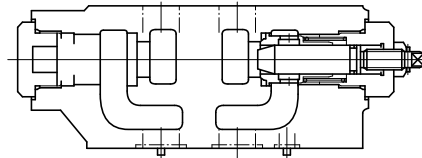

MSW-10-*-30/3090

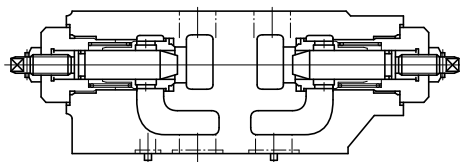

List of Seals

Item	Name of Parts	Part Numbers	Quantity		
			MSA-10	MSB-10	MSW-10
10	Back Up Ring	SO-BB-P20	1	1	2
11	O-Ring	SO-NB-P16	2	2	2
12	O-Ring	SO-NA-P20	1	1	2
13	O-Ring	SO-NB-P40	4	4	4
14	O-Ring	SO-NB-P44	2	2	2

Note: When ordering seals, please specify the seal kit number from the table right.

List of Seal Kits

Valve Model Numbers	Seal Kit Numbers
MSA-10	KS-MSA-10-10
MSB-10	
MSW-10	KS-MSW-10-10

Pilot Operated Check Modular Valves

Specifications

Model Numbers	Max. Operating Pressure MPa (PSI)	Max. Flow L/min (U.S.GPM)
MPA-10*-**-30/3090 MPB-10*-**-30/3090 MPW-10*-**-30/3090	25 (3630)	800 (211)

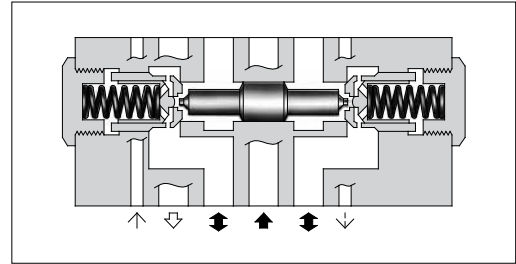

Model Number Designation

F-	MPA	-10	S	-2	-X	-30	*
Special Seals	Series Number	Valve Size	Port Tapping Feature of Pilot-Drain Port ^{★1}	Cracking Pressure MPa (PSI)	Pilot-Drain ^{★2} Connection	Design Number	Design Standard
F: Special Seals for Phosphate Ester Type Fluids (Omit if not required)	MPA : Pilot Operated Check Valve for A-Line MPB : Pilot Operated Check Valve for B-Line MPW : Pilot Operated Check Valve for A&B-Lines	10	None : Taper Thread S : Straight Thread (Applicable only for Japanese Std. "JIS")	2 : 0.2 (29) 4 : 0.4 (58)	None : Internal Pilot-Internal Drain X : External Pilot-External Drain Y : External Pilot-Internal Drain	30	Refer to ^{★3}

- ★1. This item applies only to External Pilot or External Drain Type.
- ★2. Only "None: Internal Pilot-Internal Drain Type" is available for MPW (for "A&B-Lines").
- ★3. Design Standards: None Japanese Standard "JIS" and European Design Standard 90 N. American Design Standard

Graphic Symbols

Pilot-Drain type Model No.	Internal Pilot-Internal Drain Type	External Pilot-External Drain Type	External Pilot-Internal Drain Type
MPA-10	 MPA-10-*	 MPA-10*-*-X	 MPA-10*-*-Y
MPB-10	 MPB-10-*	 MPB-10*-*-X	 MPB-10*-*-Y
MPW-10	 MPW-10-*	—	—

Typical Performance Characteristics

Hydraulic Fluid: Viscosity 35 mm²/s (164 SSU), Specific Gravity 0.850

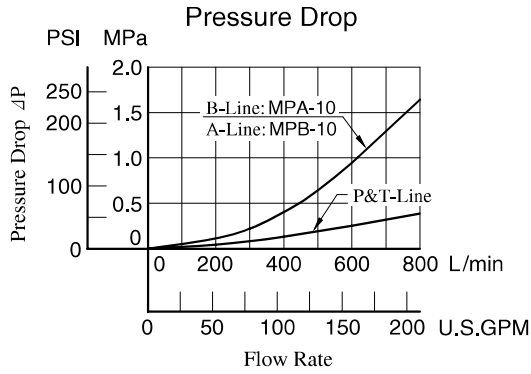

Pressure Drop for Reversed Controlled Flow

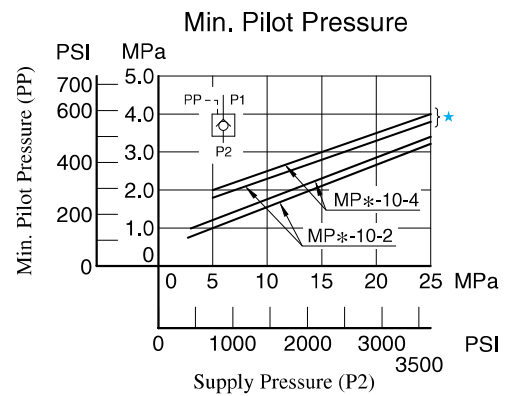
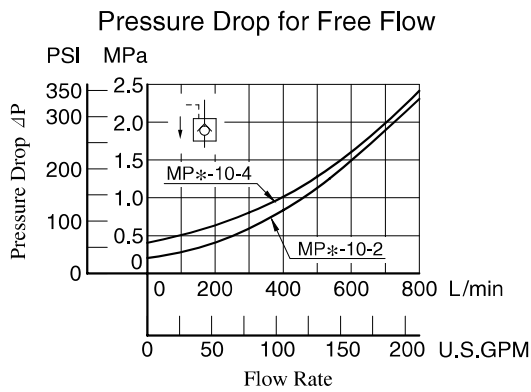
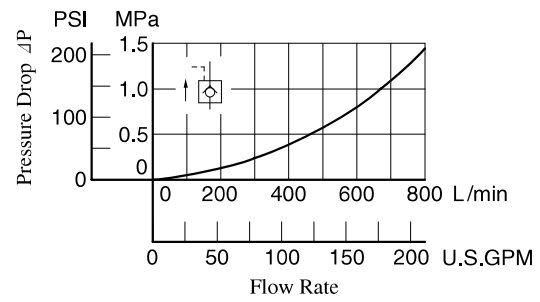

★ In case of 500 L/min (132 U.S.GPM) or more.

MPA-10-*-30/3090 (Internal Pilot-
MPB-10-*-30/3090 Internal Drain Type)
MPW-10-*-30/3090

**DIMENSIONS IN
MILLIMETRES (INCHES)**

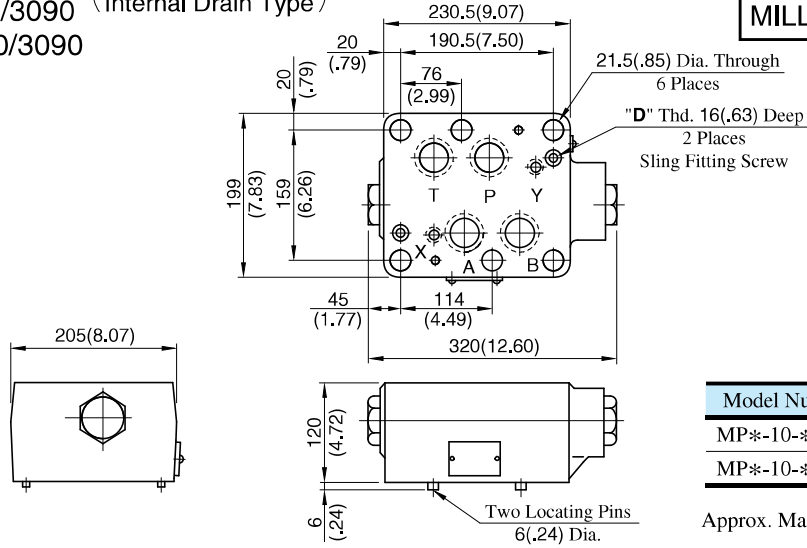

Model Numbers	"D" Thd.
MP*-10-*-30	M8
MP*-10-*-3090	5/16-18 UNC

Approx. Mass.....36.5 kg (80.5 lbs.)

MPA-10-*-X-30/3090 (External Pilot-
External Drain Type)

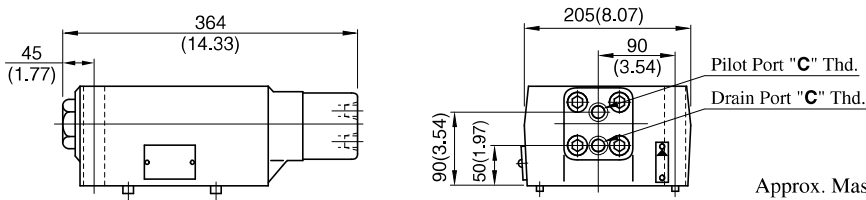

Approx. Mass.....38 kg (83.8 lbs.)

Model Numbers	Thread Size "C" Thd.
MPA-10-*-X-30	Rc 3/8 = 3/8 BSP. Tr
MPA-10-*-X-3090	3/8 NPT
MPA-10S-*-X-30	G 3/8

Approx. Mass.....36.5 kg (80.5 lbs.)

• For other dimensions, refer to "Internal pilot-Internal drain type" drawing above.

MPB-10-*-X-30/3090 (External Pilot-
External Drain Type)

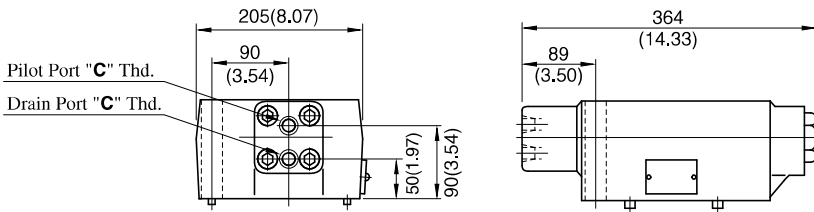

Approx. Mass.....38 kg (83.8 lbs.)

Model Numbers	Thread Size "C" Thd.
MPB-10-*-X-30	Rc 3/8 = 3/8 BSP. Tr
MPB-10-*-X-3090	3/8 NPT
MPB-10S-*-X-30	G 3/8

Approx. Mass.....36.5 kg (80.5 lbs.)

• For other dimensions, refer to "Internal pilot-Internal drain type" drawing above.

MPB-10-*-Y-30/3090 (External Pilot-
Internal Drain Type)

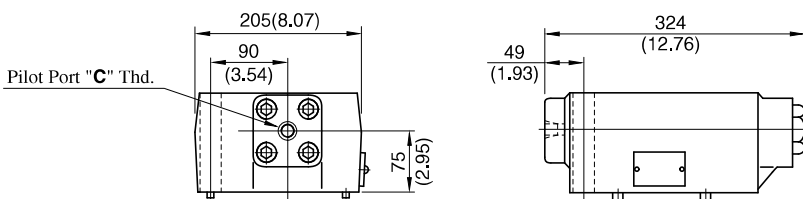

Spare Parts List

Internal Pilot- Internal Drain Type

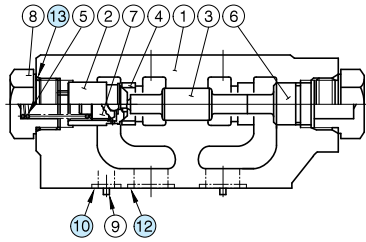

MPA-10*-30/3090

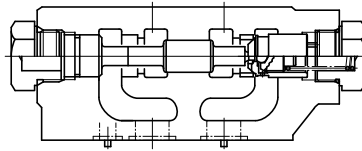

MPB-10*-30/3090

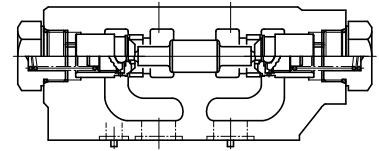

MPW-10*-30/3090

External Pilot- External Drain Type

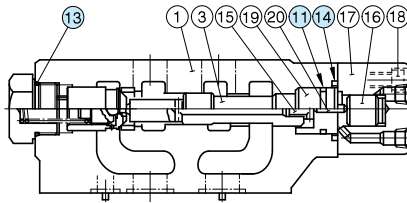

MPA-10*-X-30/3090

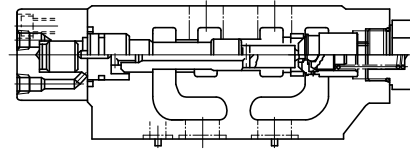

MPB-10*-X-30/3090

External Pilot- Internal Drain Type

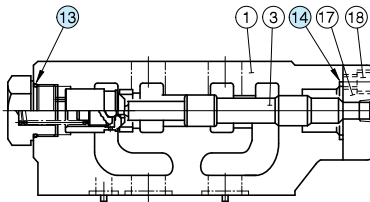

MPA-10*-Y-30/3090

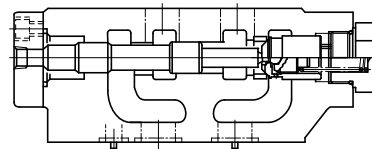

MPB-10*-Y-30/3090

List of Seals

Item	Name of Parts	Part Numbers	Quantity		
			Internal Pilot- Internal Drain	External Pilot- External Drain	External Pilot- Internal Drain
10	O-Ring	SO-NB-P16	2	2	2
11	O-Ring	SO-NB-P34	—	1	—
12	O-Ring	SO-NB-P40	4	4	4
13	O-Ring	SO-NB-P44	2	1	1
14	O-Ring	SO-NB-P46	—	1	1

Note: When ordering seals, please specify the seal kit number from the table right.

List of Seal Kits

Valve Model Numbers	Seal Kit Numbers	
MPA-10*- MPB-10*- MPW-10*-	KS-MPA-10-10	
MPA-10*-X- MPB-10*-X-		KS-MPA-10-X-10
MPA-10*-Y- MPB-10*-Y-		KS-MPA-10-Y-10

Mounting Bolt Kits For Modular Valves

Valves are mounted with six stud bolts. Valve combination varies according to the circuit type. Hence, the mounting bolt kits are available on a combination type basis. When ordering the mounting bolt kit, be sure to give the bolt kit model number from the table below.

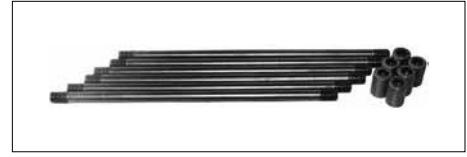

Model Number Designation

MBK	-10	-04	-10	*
Series Number	Size of Modular Valve	Bolt Number	Design Number	Design Standard
MBK : Mounting Bolt Kits for Modular Valves	10	01, 02, 03, 04	10	None : Japanese Standard "JIS" and European Design Standard 90 : N.American Design Standard

Bolt Kits Selection Chart

Model Numbers	Quantity of Valves to be Stacked		Approx. Mass kg (lbs.)
	Sol. Cont. Pilot Operated Directional Valves (*-DSHG-10)	Modular Valve	
MBK-10-01-10*	1	1	3.9 (8.6)
MBK-10-02-10*	1	2	5.7 (12.6)
MBK-10-03-10*	1	3	7.4 (16.3)
MBK-10-04-10*	1	4	9.2 (20.3)

Bolt Kit Composition

Stud Bolt ----- 6 Pcs. } 1 set
 Nut ----- 6 Pcs. }

Tightening Torque:

150-170 Nm (1330-1505 in. lbs.)

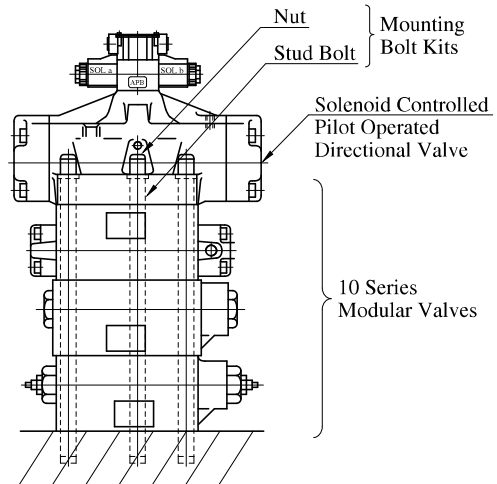

Stacking Example

MBK-10-*-10/1090

DIMENSIONS IN MILLIMETRES (INCHES)

Stud Bolt

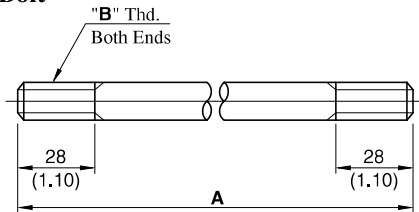

Nut

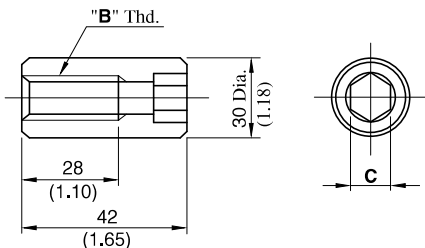

Bolt Numbers	A mm (in.)
MBK-10-01	217 (8.54)
MBK-10-02	337 (13.27)
MBK-10-03	457 (17.99)
MBK-10-04	577 (22.72)

Model Numbers	"B" Thd.	C
MBK-10-*-10	M20	17 (.67)
MBK-10-*-1090	3/4-10 UNC	15.9 (5/8)

■ Mounting Surface Dimensions for 1-1/4 Modular Valve

When mounting 10 series modular valve, be sure to use a sub-plate for 1-1/4 solenoid controlled pilot operated directional valves.

Name	Sub-plate Model Number	Page
Sub-plate for 1-1/4 Solenoid Controlled Pilot Operated Directional Valves	DHGM-10*-40/4080/4090	403

When no sub-plates are used, be sure to use the following mounting surface.

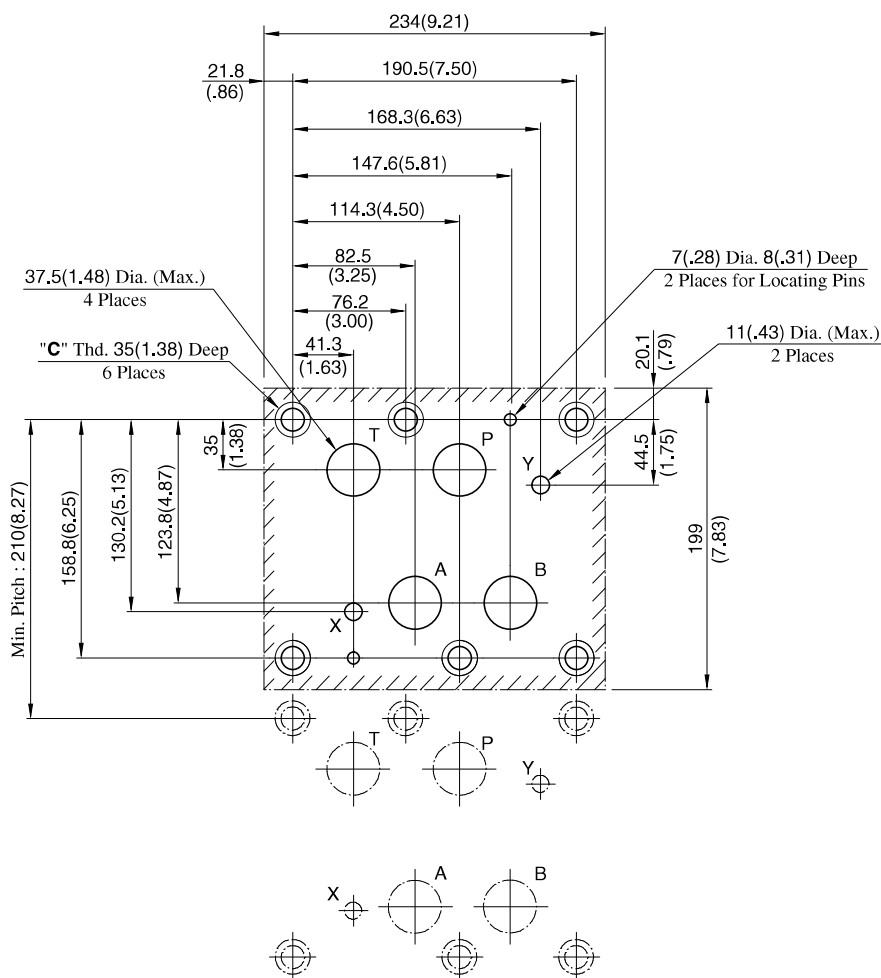

Design Std.	"C" Thd.
Japanese Std. "JIS" and European Design Std.	M20
N. American Design Std.	3/4-10 UNC